

INJECTION WAFER DATA SHEET (IW- SERIES)



Injection Wafers are designed to be installed between flanges — sandwiched between the pipe flange and a mating flange.

Injection wafers can be used as simplified injection ports for installing injection quills. For sludge dewatering applications they can be used for injecting dilute polymer around the perimeter of a flow.

Styles Available

Injection wafers are available with:

- Threaded ports
- Flanged ports

Injection wafers can be provided with:

- Full Flange design (including bolt holes)
- Ring style design which fits within the bolt circle of the flange bolts

Simplifies Chemical Injection

Provides a chemically compatible material for chemical injection or installation of injection quills.

Ease of Installation

Injection Wafers allow easy installation of injection points into an existing or new pipeline. If you can find 2" of play in the pipeline, a wafer can be installed quickly and easily with little downtime.

Materials of Construction

Injection Wafers are available in many materials including:

- PVC & CPVC
- Stainless Steel
- Epoxy Coated Carbon Steel

Other materials such as HDPE and Kynar may be available

**IW SERIES INJECTION WAFERS ARE
DESIGNED FOR INSTALLATION
BETWEEN 150# FLANGES.**

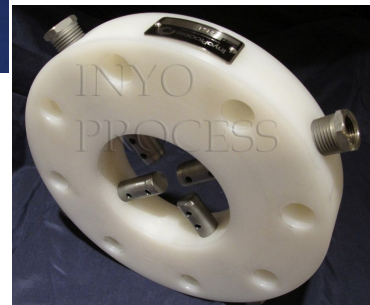
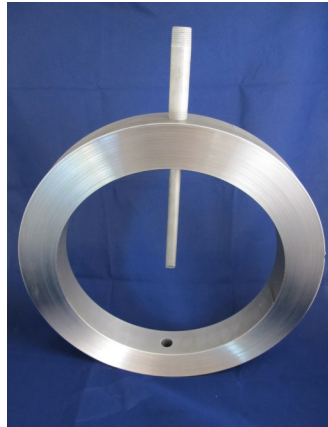

Clockwise from top:

- Ring style SS injection wafer shown with optional threaded injector.*
- Full Face PVC injector with (4) NPT ports. For dilute polymer injection into sludge.*
- Custom Full Face injection wafer constructed of Kynar with optional multi-hole diffusers for a slurry mixing application.*
- Ring style SS injection wafer with flanged port.*

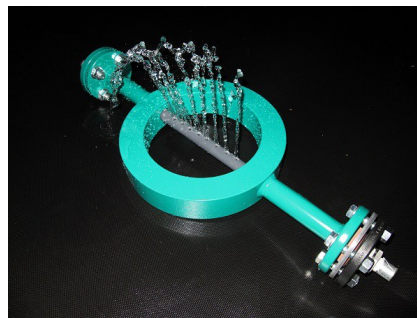

Above: A flanged ring style injection wafer constructed from epoxy coated steel. Shown with dual ports and an optional multi-hole diffuser for providing maximum dispersion of a chemical in a pipeline.

MODEL NUMBER

IW - R - P - 4 - 3 - 3/4 - F - 180

WAFER STYLE

- FULL FACE FLANGE (F)
- RING STYLE (R)

MATERIAL

SPOOL DIAMETER (IN)

NUMBER OF PORTS

INJECTION PORT
DIAMETER (IN)

FLANGED PORT (F)
OR NPT THREADED (T)

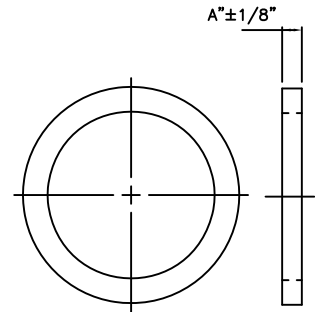

TYPICAL CONFIGURATIONS

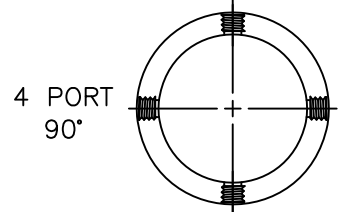
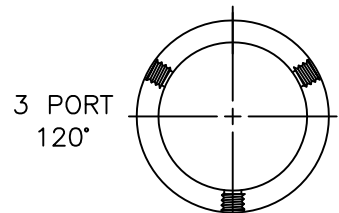
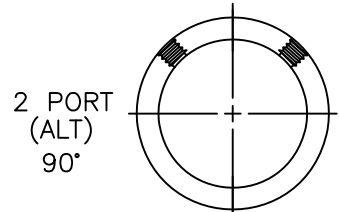
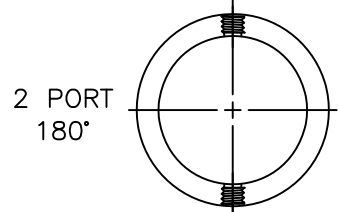
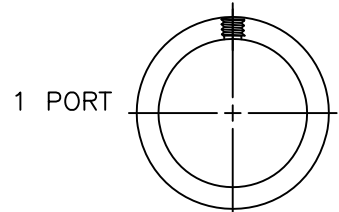

ANGLE OF SEPARATION BETWEEN PORTS

- (LEAVE EMPTY IF ONLY ONE PORT)
- 2 PORTS IS TYPICALLY 180° OR 90°
- 3 PORTS IS TYPICALLY 120°
- 4 PORTS IS TYPICALLY 90°

150# & 125# CLASS ANSI FLANGE TABULATION BLOCK			
LINE SIZE NPS	I.D. (in)	O.D. (in)	"A" THICKNESS (in)
3	3.07	5.13	1-1/2" THK FOR 1/2" PORT
4	4.03	6.63	
6	6.07	8.5	
8	7.98	10.75	
10	10.02	13.13	2" THK FOR 3/4" & 1" PORT
12	12	15.88	
14	13.25	17.51	
16	15.25	20.01	
18	17.25	21.38	
20	19.25	23.63	
24	23.25	28.00	

SYMBOL	MATERIAL	RATING
C	EPOXY LINED CARBON STEEL	240 PSIG/200°F
S	STAINLESS STEEL	240 PSIG/200°F
CP	CPVC	100 PSIG/165°F
P	PVC	150 PSIG/100°F

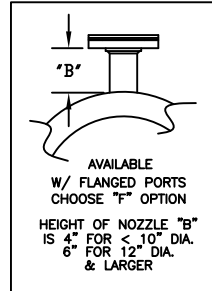

NOTES:

- 1" PORT SIZE REQUIRES A 2" THICK "A" WAFER
- LARGER DIAMETERS ARE AVAILABLE PLEASE CALL FACTORY
- CUSTOM CONFIGURATIONS ARE AVAILABLE
- ALSO AVAILABLE FOR DIN, AUSTRALIAN & BRITISH FLANGES
- CUSTOM SIZES AND CUSTOM PORT ARRANGEMENTS AVAILABLE. CALL FACTORY FOR PART NUMBERS
- AVAILABLE WITH MATCHING GASKETS IN ALL STANDARD MATERIALS INCLUDING: VITON NEOPRENE, BUNA, EPDM, TEFLON

UNLESS OTHERWISE SPECIFIED	PROJECT NO.	STANDARD	INYO PROCESS							
	DRAWN	RT								
DIMENSIONS ARE IN INCHES DO NOT SCALE DRAWING	CHECKED	ES	STANDARD INJECTION WAFER							
	DESIGN APPROVED	-								
	MFG. APPROVED	-								
	QA APPROVED	-								
	RELEASE DATE	9-11-11					SCALE	NTS	WEIGHT	SHEET
										1 OF 1
			SIZE A	DRAWING NO	REV					
				IW-1000	2					