

MODEL NUMBER

IW - R - P - 4 - 3 - 3/4 - F - 180

WAFER STYLE

- FULL FACE FLANGE (F)
- RING STYLE (R)

MATERIAL

SPOOL DIAMETER (IN)

NUMBER OF PORTS

INJECTION PORT DIAMETER (IN)

FLANGED PORT (F) OR NPT THREADED (T)

ANGLE OF SEPARATION BETWEEN PORTS

(LEAVE EMPTY IF ONLY ONE PORT)

2 PORTS IS TYPICALLY 180° OR 90°

3 PORTS IS TYPICALLY 270° (90° EACH)

4 PORTS IS TYPICALLY 90°

150# & 125# CLASS ANSI FLANGE TABULATION BLOCK	
LINE SIZE NPS	"A" THICKNESS (in)
3	1-1/2" THK FOR 1/2" PORT
4	
6	
8	
10	2" THK FOR 3/4" (PVC & METAL) 1" PORT (METAL)
12	
14	
16	3" THK FOR 1" PORT (PVC)
18	
20	
24	

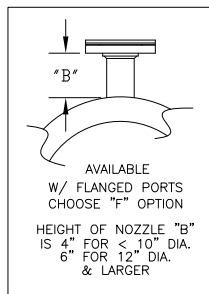

SYMBOL	MATERIAL	RATING
C	EPOXY LINED CARBON STEEL	240 PSIG/200°F
S	STAINLESS STEEL	240 PSIG/200°F
CP	CPVC	100 PSIG/165°F
P	PVC	150 PSIG/100°F
H	HDPE	NOT RATED

NOTES:

1. LARGER DIAMETERS ARE AVAILABLE PLEASE CALL FACTORY
2. ALSO AVAILABLE FOR DIN, AUSTRALIAN & BRITISH FLANGES
3. CUSTOM SIZES AND CUSTOM PORT ARRANGEMENTS AVAILABLE. CALL FACTORY FOR PART NUMBERS
4. AVAILABLE WITH MATCHING GASKETS IN ALL STANDARD MATERIALS INCLUDING: VITON NEOPRENE, BUNA, EPDM, TEFLON

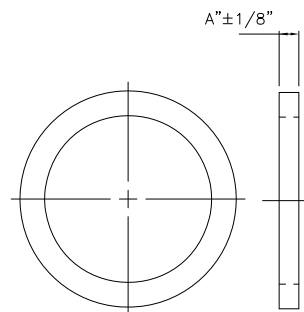

TYPICAL CONFIGURATIONS

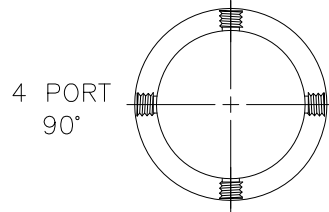
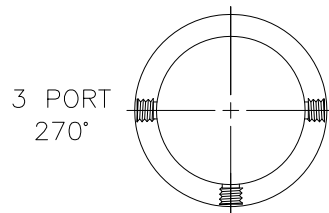
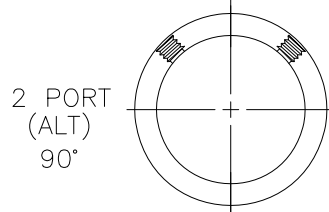
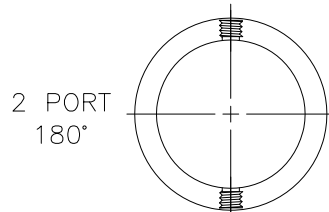
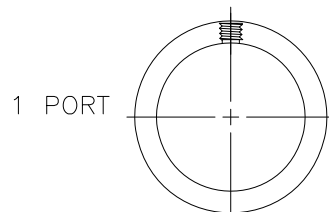

UNLESS OTHERWISE SPECIFIED DIMENSIONS ARE IN INCHES DO NOT SCALE DRAWING	PROJECT NO.	STANDARD	INYO PROCESS			
	DRAWN	RT				
	CHECKED	ES	STANDARD INJECTION WAFER			
	DESIGN APPROVED	-				
	MFG. APPROVED	-	SIZE	DRAWING NO	REV	
	QA APPROVED	-	A	IW-1000	3	
RELEASE DATE	9-11-11	SCALE	NTS	WEIGHT	SHEET 1 OF 1	